

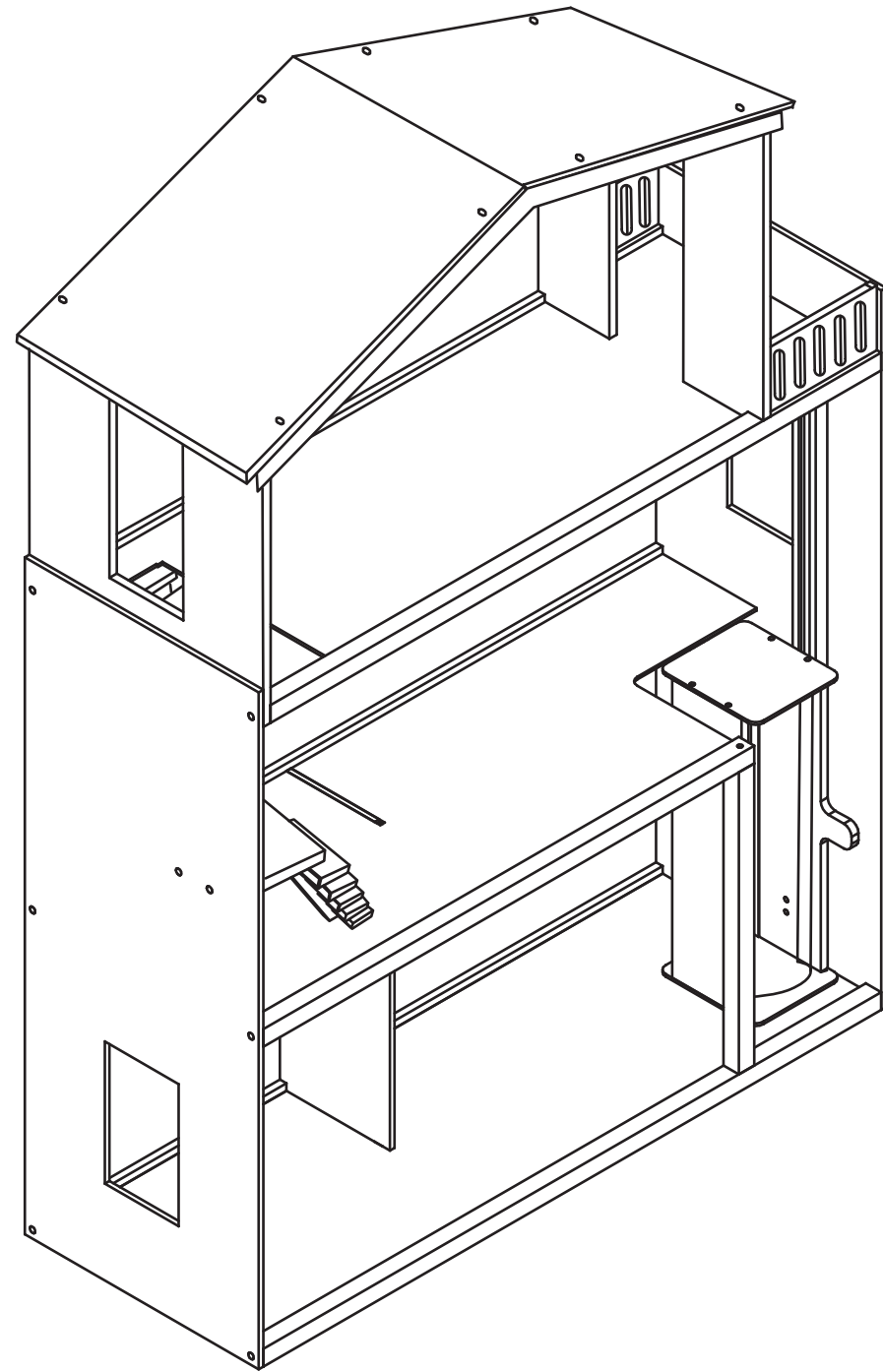















Doll House Assembly Instruction

Item No. 5219

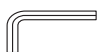

HARDWARE

- A. White cross dowel bolt x 11 (58mm) 
 - B. Cross dowel nut x 11 
 - C. Large head screw x 2 (42mm) 
 - D. Rosy head screw x 4 (32mm) 
 - E. White large head screw x 2 (16mm) 
 - F. Large head screw x 2 (24mm) 
 - G. White head screw x 4 (24mm) 
 - H. White large head screw x 6 (24mm) 
 - I. White large head screw x 2 (24mm) 
 - J. White large head screw x 8 (18mm) 
 - K. Black large head screw x 8 (18mm) 
 - L. Silvery large head screw x 4 (18mm) 
 - M. Pink large head screw x 1 (16mm) 
 - N. Large head screw x 3 (13mm) 
 - O. Small rosy head screw x 1 (10mm) 
- Allen wrench x 1 

PARTS LIST

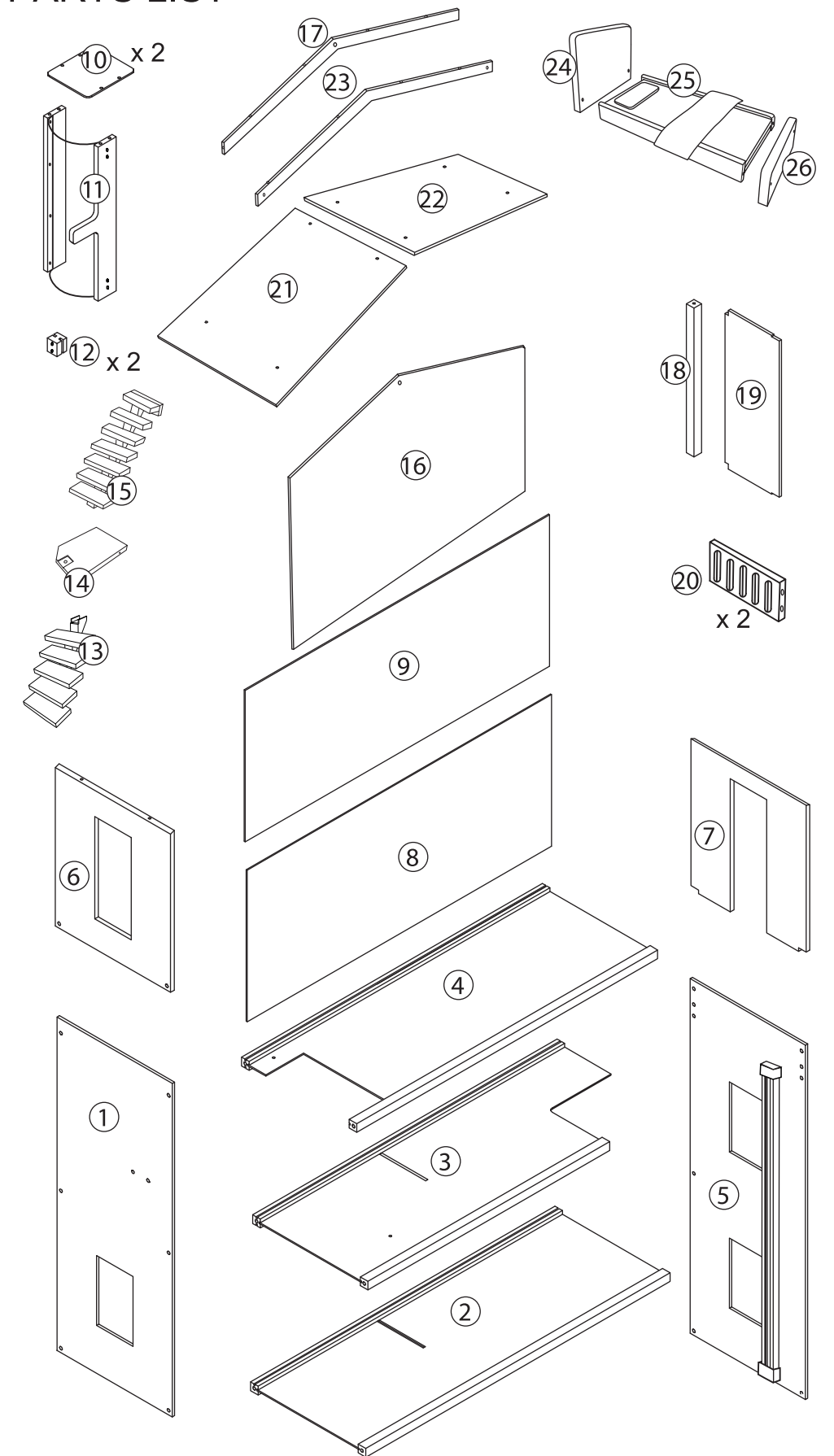

WARNING !

Not suitable for children under 3 years due to small parts. CHOKING HAZARD !
Hardware contains small screws with sharp points.
Children shall not climb or pull on the doll house .

CAUTION !

Adult assembly required.
Regularly check the screws are tight.
Wipe clean with a damp cloth.
Keep this information for future reference.



STEP 1

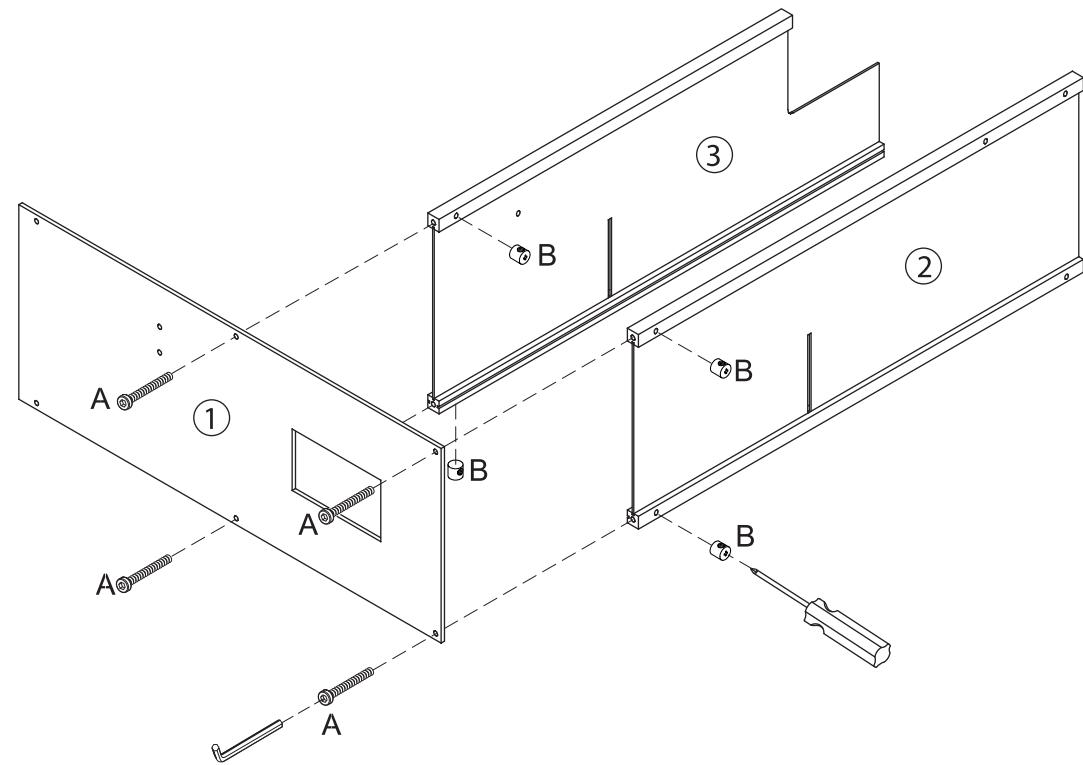

STEP 2

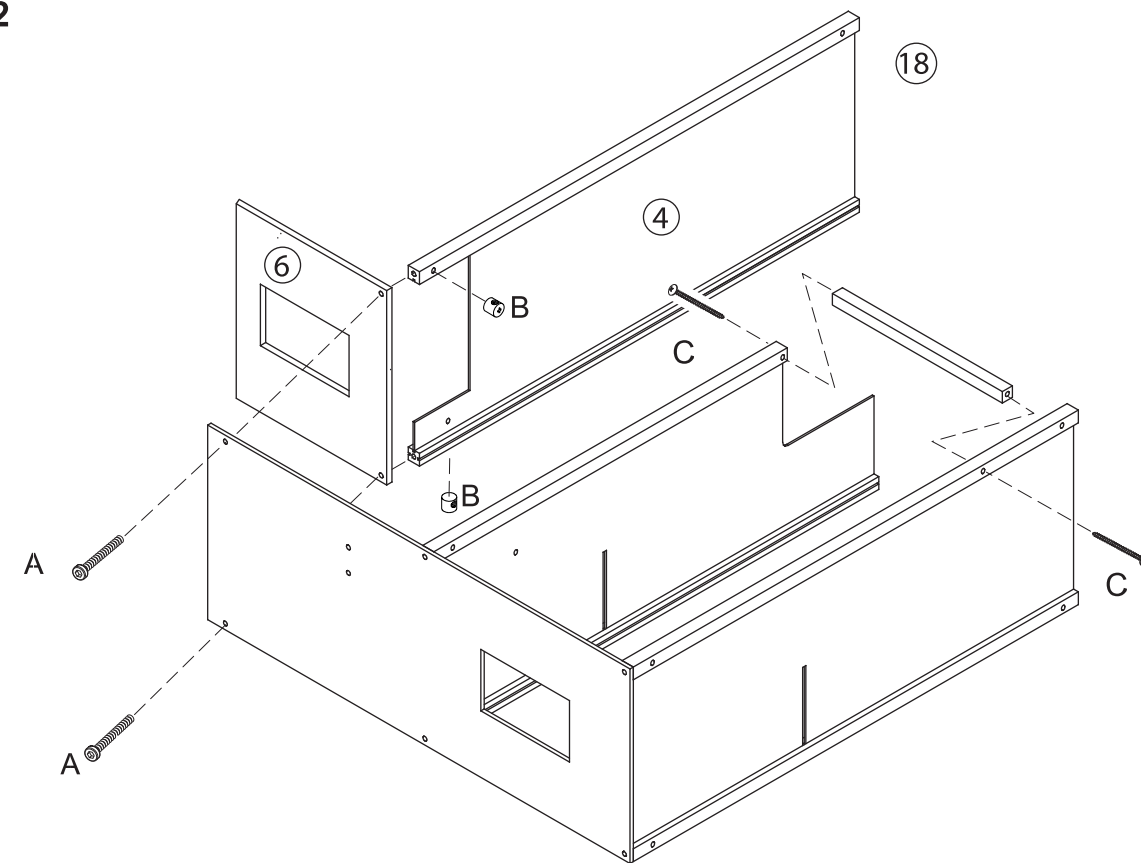

STEP 3

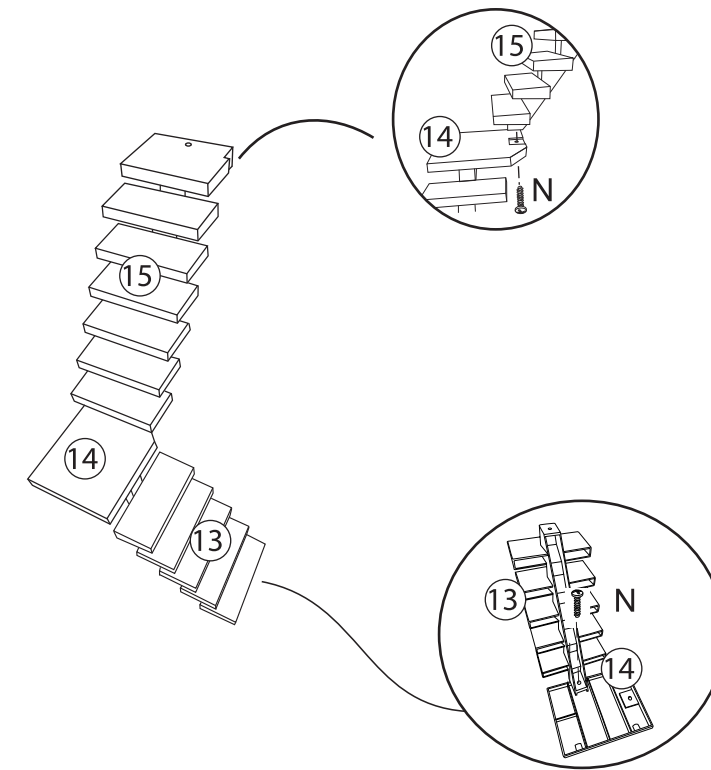

STEP 4

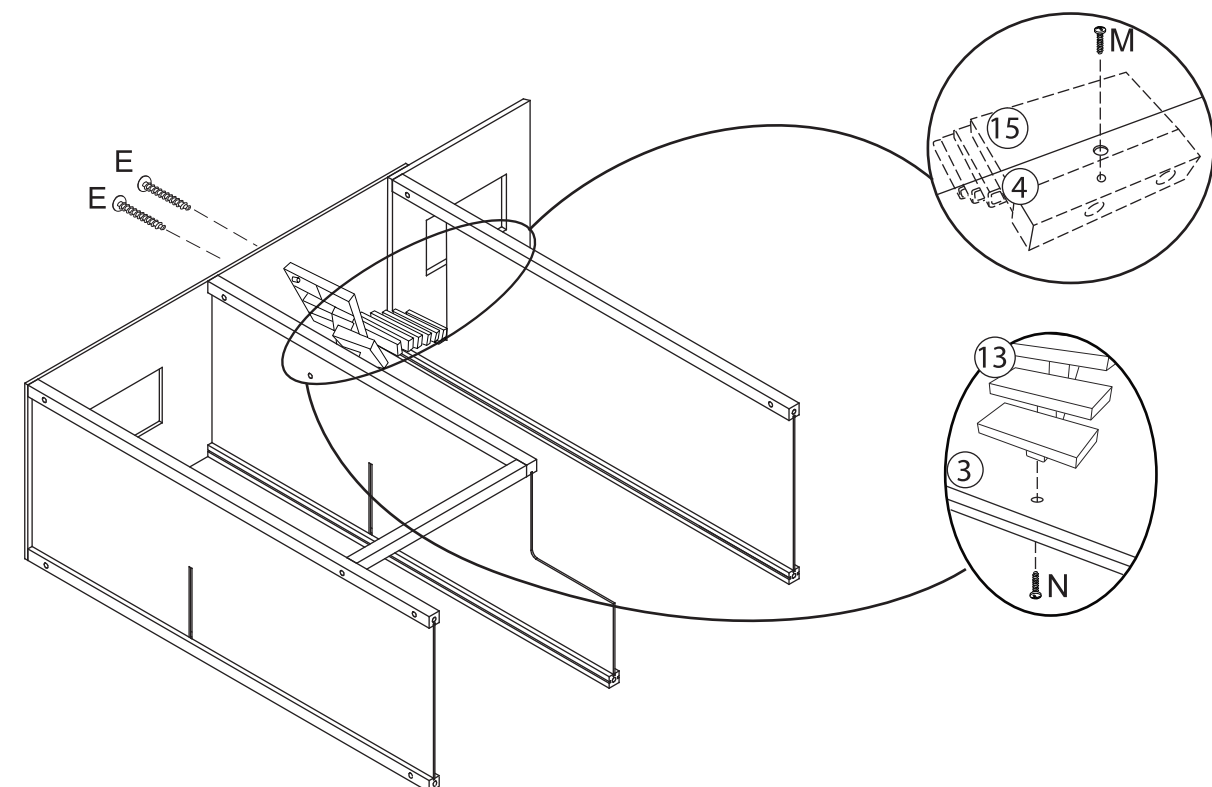

STEP 5

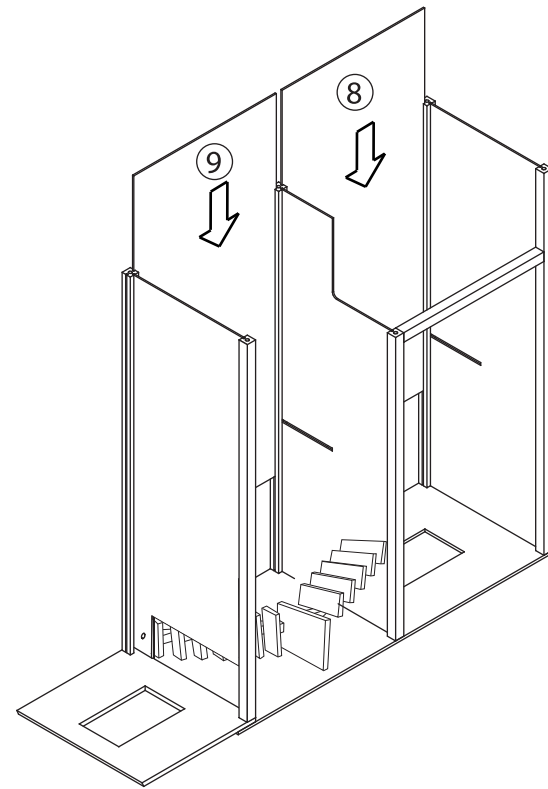

STEP 8

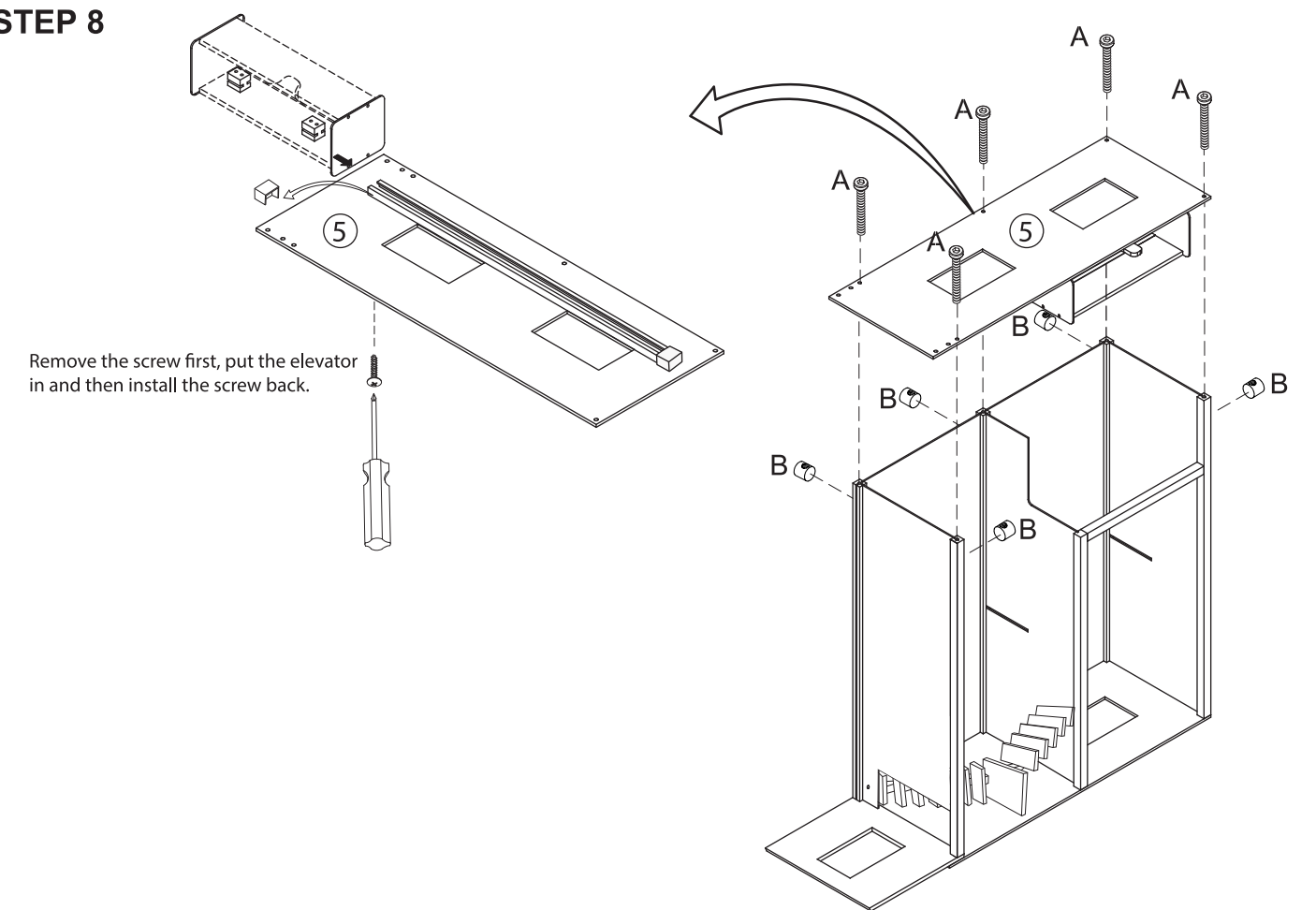

STEP 6

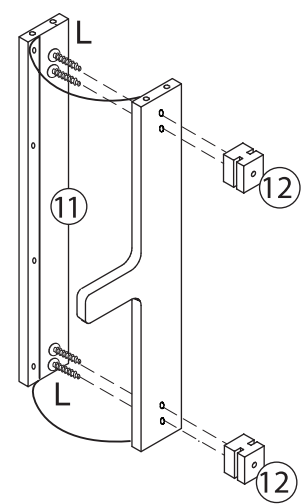

STEP 7

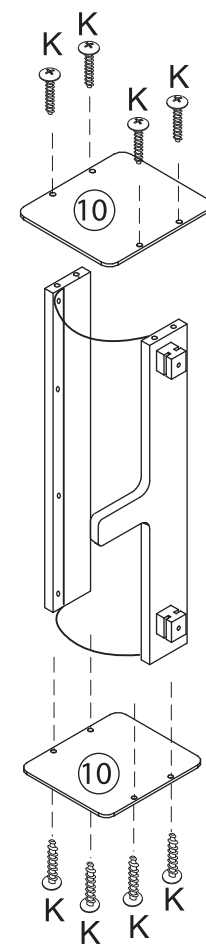

STEP 9

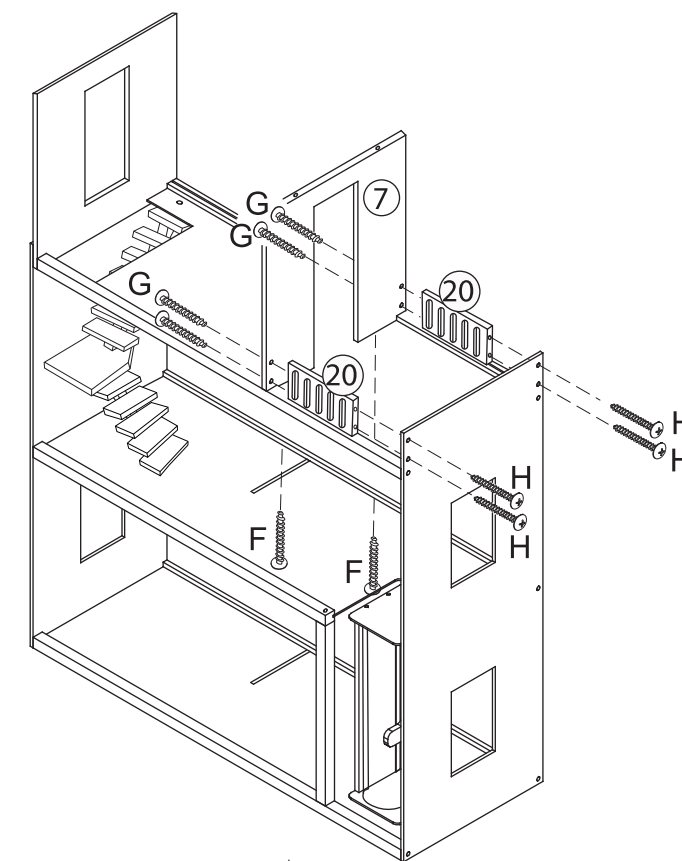

STEP 10

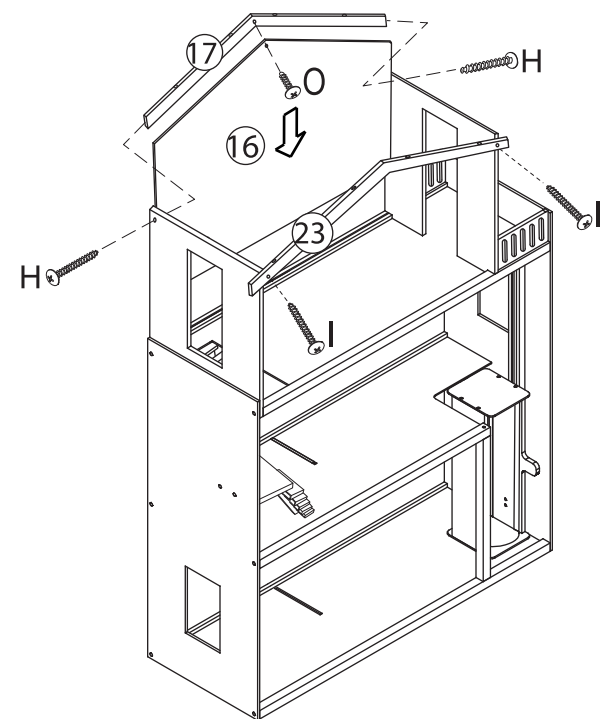

STEP 11

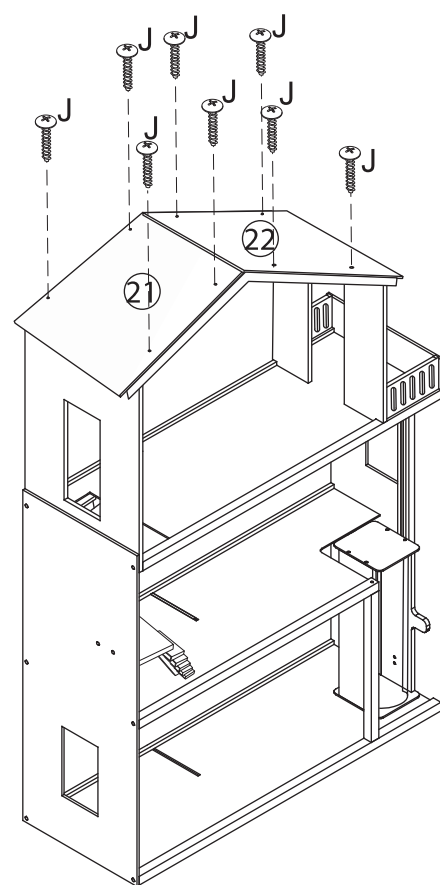

STEP 12

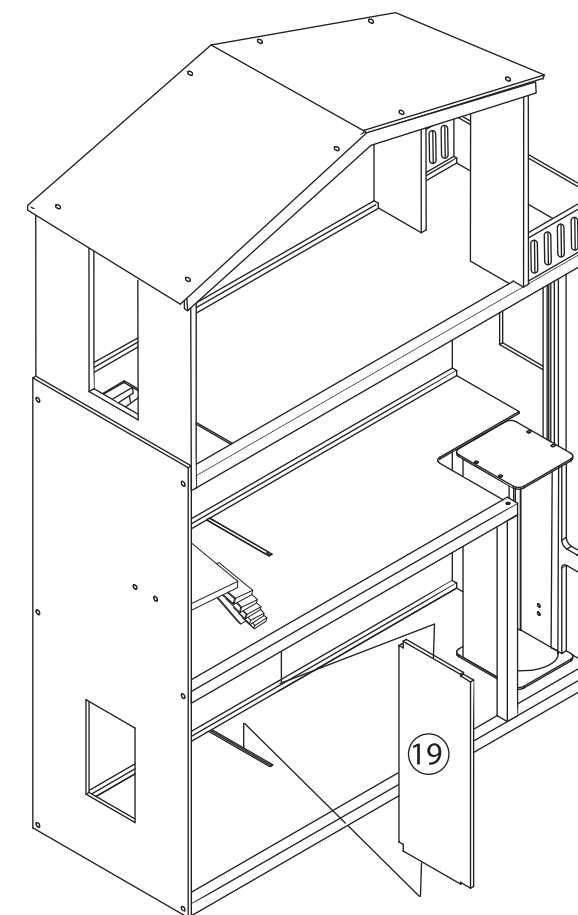

Bed Assembly

